

Orientalmotor

Stepper Motor **PKP Series**

Additions to the Product Line

2-Phase SH Geared Type	Frame Size 28 mm
5-Phase Standard Type	Frame Size 28 mm
High-Resolution Type	Frame Size 28 mm
	Frame Size 42 mm
	Frame Size 60 mm



Stepper Motor PKP Series



2-Phase

Stepper Motors **PKP** Series

High Torque

Low Vibration

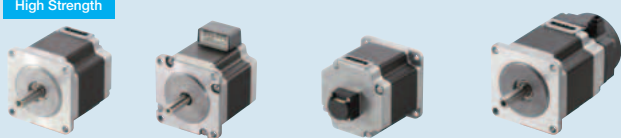
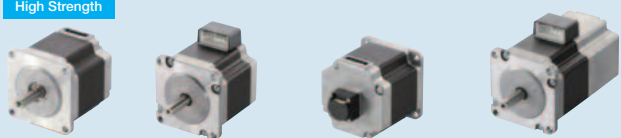
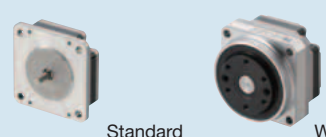
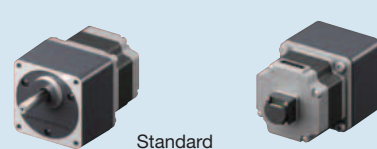
● Bipolar (4 lead wires) and unipolar (5 or 6 lead wires) wiring types are available.

Motor Type	Motor Frame Size	Additional Function		
		Standard	With Encoder	With Electromagnetic Brake
Standard Type (Basic Step Angle: 1.8°/step) High Strength  Flat-Connector Type Connector Type With Encoder With Electromagnetic Brake Standard	□ 20 mm	●	●	—
	□ 28 mm	●	●	●
	□ 35 mm	●	●	●
	□ 42 mm	●	●	●
	□ 56.4 mm	●	●	●
	□ 60 mm*1	●	—	—
	□ 85 mm	●	—	—
	High-Resolution Type (Basic Step Angle: 0.9°/step) High Strength  Flat Connector Type Connector Type With Encoder With Electromagnetic Brake Standard	□ 28 mm	●	●
□ 42 mm		●	●	●
□ 56.4 mm		●	●	●
Flat Type (Basic Step Angle: 0.018° to 1.8°/step)  Standard With Harmonic Gears		□ 42 mm	●	—
	□ 60 mm	●	—	—
	□ 51 mm	With Harmonic Gears		
	□ 61 mm	With Harmonic Gears		
SH Geared Type (Basic Step Angle: 0.05° to 0.5°/step)  Standard With Encoder	□ 28 mm	●	NEW	—
	□ 42 mm	●	●	—
	□ 60 mm	●	●	—
	□ 90 mm*1	●	—	—
CS Geared Type (Basic Step Angle: 0.09 to 0.36°/step)  Standard	□ 28 mm	●	—	—
	□ 42 mm	●	—	—
	□ 60 mm	●	—	—



●: 2 types are available—the "Flat Connector Type" and the "Connector Type".

*1 This is the conventional **PK** Series.

5-Phase Stepper Motors **PKP** Series

High Accuracy

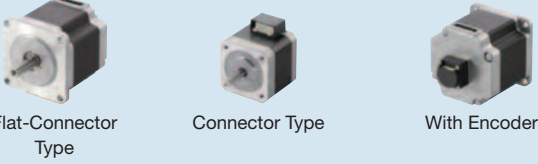
Low Vibration

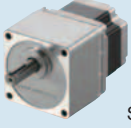
Motor Type	Motor Frame Size	Additional Function		
		Standard	With Encoder	With Electromagnetic Brake
Standard Type (Basic Step Angle: 0.72°/step) High Strength  Flat-Connector Type Connector Type With Encoder Standard	□ 20 mm*1	●	●	—
	□ 28 mm	●	NEW	—
	□ 42 mm	●	●	—
	□ 56.4 mm	●	●	—
	□ 60 mm	●	●	—
	□ 85 mm*1	●	—	—
High-Resolution Type (Basic Step Angle: 0.36°/step)  Standard	□ 28 mm	●	NEW	—
	□ 42 mm	●	NEW	—
	□ 60 mm	●	NEW	—
TS Geared Type (Basic Step Angle: 0.024 to 0.2°/step)  Standard	□ 42 mm	●	—	—
	□ 60 mm	●	—	—



●: 2 types are available—the "Flat Connector Type" and the "Connector Type".

*1 This is the conventional **PK** Series.

2-Phase 5-Phase Driver for Stepper Motors

Compact

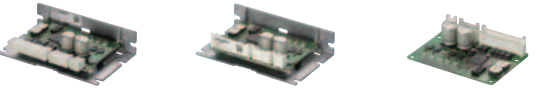
Low Vibration

Bipolar Driver for 2-Phase Stepper Motors Driver for 5-Phase Stepper Motors CVD Series—Pulse Input Type	 Right Angle with Installation Plate With Installation Plate Without Installation Plate
Bipolar Driver for 2-Phase Stepper Motors Driver for 5-Phase Stepper Motors CVD Series RS-485 Communication Type	 Right Angle with Installation Plate With Installation Plate
Bipolar Driver for 2-Phase/5-Phase Stepper Motors CVD Series S Type Driver for 5-Phase Stepper Motors CVD Series SC Type	● CVD Series S Type *2  · SPI Communication-Compatible · Pulse Input-Compatible

*2 For details, please contact your nearest Oriental Motor sales office.

2-Phase Stepper Motors PKP Series

● For detailed information about regulations and standards, please see the Oriental Motor website.

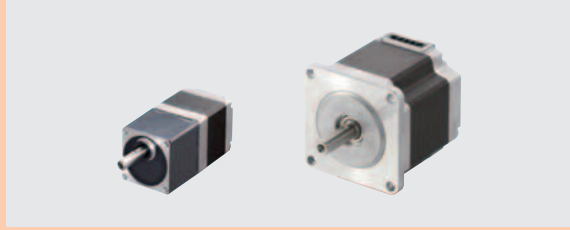

Introducing our Video Library

Videos presenting the features, operations, and methods of use, etc. of the **PKP** Series are available on the Oriental Motor website.

These products are high-torque 2-phase stepper motors. A wide variety of products are available to meet your design specifications.

- Motor Frame Size 13 mm to 85 mm
- Standard Type with a Resolution of 200 Steps per Revolution (Basic step angle: 1.8°/step)
- High-Resolution Type with a Resolution of 400 Steps per Revolution (Basic step angle: 0.9°/step)
- Oriental Motor's Flat Type 2-phase Stepper Motor
- High-Torque and High-Resolution **SH** Geared Type
- Bipolar (4 lead wires) and Unipolar (5 or 6 lead wires) are Available
- Encoder Type and Electromagnetic Brake Type are Available
- Many Motor Current Specifications Available

Features

Increased Torque over the Entire Speed Range from Low to High

After revising the magnetic design and structure design of the **PKP** Series, it produces much more torque than standard **PK** Series motors of the same size. In addition, torque can be increased in the high-speed range by using high current motors.

Comparison of Speed – Torque Characteristics of the Same Size Motors

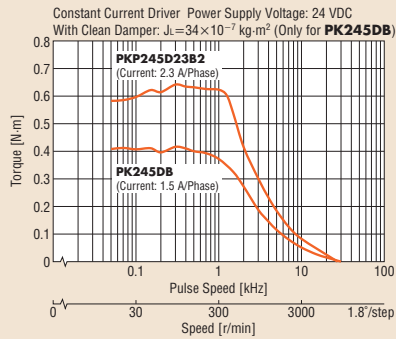

High current is possible due to the revised motor winding design and the highly efficient design of the drive circuit that can be combined. Increased torque over the entire speed range from low to high is achieved.

Comparison of Maximum Holding Torque

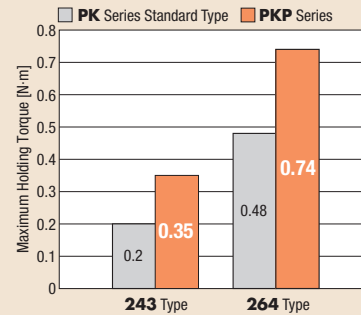

Conservation of Energy and Electrical Power

Reducing the running current supplied to **PKP** Motors achieves the same torque as conventional products while reducing power consumption and CO₂ emissions.

Reduced Running Current with the PKP Series

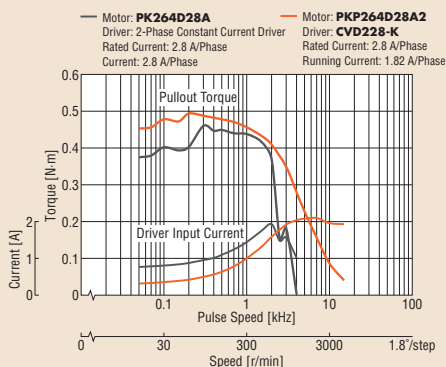

Power Consumption and CO₂ Emissions 56% Lower than Conventional Products

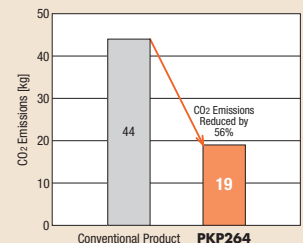

Speed 0.1 kHz (30 r/min)
Operating Time 24 hours, 365 days
Operating Conditions 50% operating, 50% stand-by
Power Supply Voltage 24 VDC
CO₂ Coefficient 0.519 kg-CO₂/kWh

Compact and Flat Connector

The **PKP** Series uses a compact flat connector, which shortens the length of the connector's overhang. In addition, the degree of freedom for the cable outlet direction has been increased because the outlet direction points upward.

● Since the connector is provided for select products only, please refer to the dimensions of each model for details.

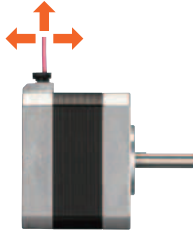

Lower Vibration

Revising the magnetic design has achieved lower vibration than with conventional products.

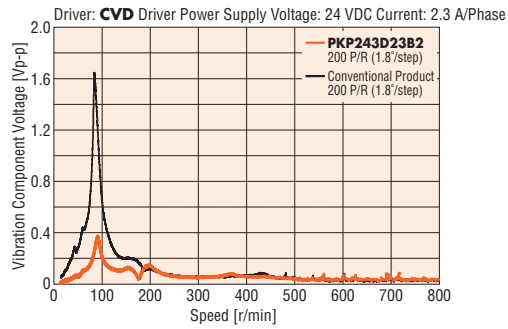

Saving Resources through Downsizing

Use a **PKP** Series motor in place of a standard motor from the **PK** Series with the equivalent torque in order to downsize motors.

Volume reduced by 44%

Comparison of Torque Characteristics of **PKP244U12A2** and **PK264-02A**

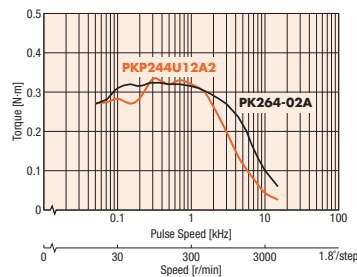

Downsizing is Possible with the Same Torque!

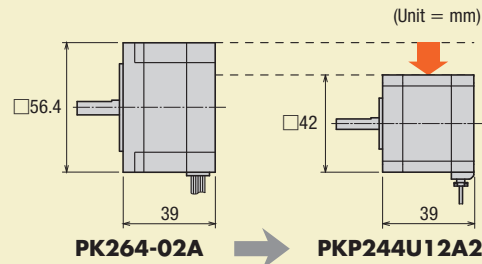

Select Motors by Specifications and Characteristics

The Flat Connector Type and Connector Type are available in some Standard Type and High-Resolution Type product lines. You can choose according to your desired specifications and characteristics.

● Comparison of the Flat Connector Type and the Connector Type For 2-Phase Stepper Motors

Type	Flat Connector Type	Connector Type
Type		
Features	<ul style="list-style-type: none"> Using a compact flat connector that shortens the length of the connector's overhang High permissible radial load / permissible axial load High torque (excluding some types) 	Standard Performance
Permissible Radial Load (Max. value)	□42 mm: 85 N (63% Increase) □56.4 mm: 270 N (68% Increase)	52 N / 160 N
Permissible Axial Load	□42 mm: 15 N (50% Increase) □56.4 mm: 30 N (50% Increase)	10 N / 20 N

◆ Example of comparison of Torque characteristics with the same size motor (□42 mm bipolar)

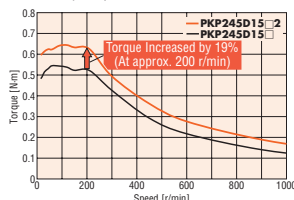

● Permissible Radial Load Increased

By increasing the permissible radial load, the Flat Connector Type make assembling equipment easier.

◇ Applications Belt and Pulley Mechanism

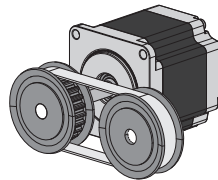

◇ Advantages

- The components for supporting the radial load on the shaft are no longer needed, making it easier to reduce the size of the equipment.
- It is easy to adjust belt tension to obtain a higher safety factor in the tension of the belt.

● Increased Torque

The torque characteristics of the Flat Connector Type is equal to or higher than those of the Connector Type (excluding some types). Reduced positioning time is achieved by increasing torque.

High-Resolution Type

This is a high-resolution stepper motor with a basic step angle of 0.9° . Stopping accuracy is improved.

● Increased Resolution (Compared to standard type)

The number of rotor teeth has doubled to 100, compared to 50 with the standard type. As a result, the basic step angle is $0.9^\circ/\text{step}$, which is half than the standard type.

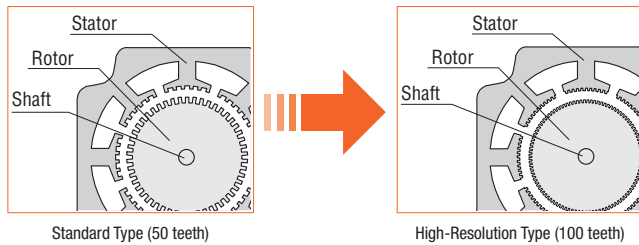

● Avoidance of Resonance Regions

If the pulse speed is within a resonance region, vibration may increase. Resonance regions can be avoided by switching to a high-resolution type.

● Improved Stopping Accuracy

Compared with the standard type (basic step angle 1.8°), the displacement angle of the motor is smaller when friction load is applied to the motor shaft. The stopping accuracy in applications that constantly apply a frictional load, such as a ball screw mechanism, is therefore improved.

◇ Comparison of Angles and Torque Characteristics* (Reference value)

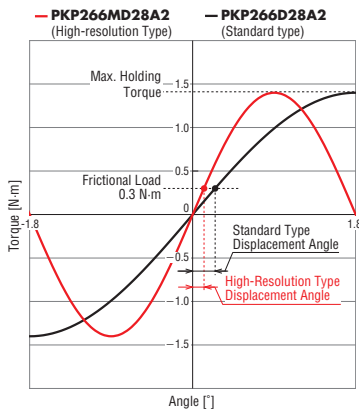

*For frictional load 0.3 N-m

◇ Comparison of Displacement Angles by Frictional Load* (Reference value)

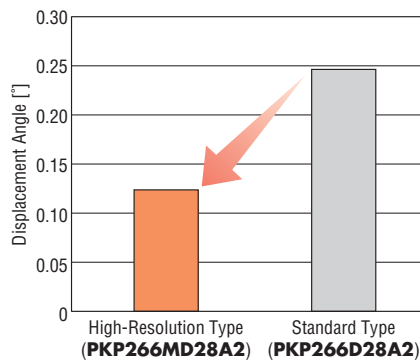

*For frictional load 0.3 N-m

◇ Example of Mechanism where a Constant Frictional Load is Applied

For example, in a ball screw mechanism, as the one shown in the figure, a frictional load is constantly applied to the motor by the guide block and guide rail, etc.

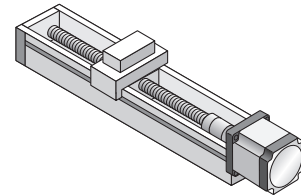

Flat Type

This is Oriental Motor's flattest type of 2-phase stepper motors.

● Flat and Lightweight Design

The motor can be installed in a narrow space.

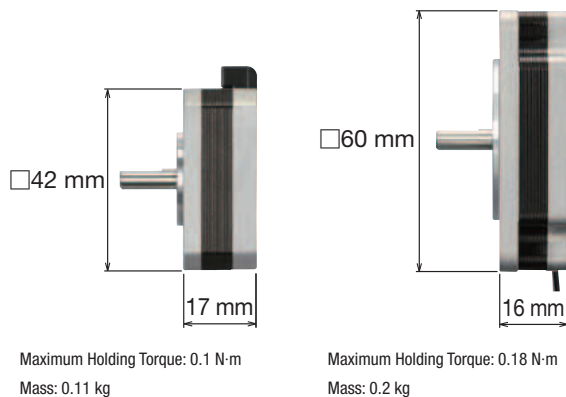

● With Harmonic Gears

◇ Attach the load to the surface of the flange to fix the load.

Example: Frame Size 51 mm



Gear Ratio 100
Maximum Holding Torque: 2.4 N-m
Mass: 0.32 kg

◇ Makes drives with large inertia possible.

Example: Frame Size 51 mm

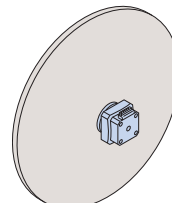

Inertia 0.12 kg-m²
(Approximately 7 times the rotor inertia)
Inertial Load: Diameter 0.35 m,
Thickness 0.01 m
Mass 7.6 kg, Material Iron
Motor: Length 17 mm
Gear Ratio 100

Features of Geared Types

Using a geared type motor can provide advantages such as deceleration, high torque, and high resolution.

● Differentiating Features of the CS Geared Type and the SH Geared Type

Type		CS Geared Type	SH Geared Type
Features		<ul style="list-style-type: none"> ● Center Shaft Configuration ● High Torque ● High Permissible Radial Load 	<ul style="list-style-type: none"> ● Wide Variety ● 90 mm Frame Size and Unipolar Wiring ● Includes Encoder ● Many Gear Ratio Types
Frame Size	28 mm	Maximum Holding Torque [N·m]	0.4~0.8
		Speed Range (Max. value) [r/min]	300~600
		Permissible Radial Load (Max. value) [N]	73
	42 mm	Maximum Holding Torque [N·m]	0.5~2
		Speed Range (Max. value) [r/min]	150~600
		Permissible Radial Load (Max. value) [N]	96
	60 mm	Maximum Holding Torque [N·m]	1.3~4.5
		Speed Range (Max. value) [r/min]	150~600
		Permissible Radial Load (Max. value) [N]	260
	90 mm	Maximum Holding Torque [N·m]	—
		Speed Range (Max. value) [r/min]	—
		Permissible Radial Load (Max. value) [N]	400

CS Geared Type

The geared type with center shaft addresses torque, shaft load capacity and installation demands.

● Increased shaft load capacity reduces assembly time

Increased permissible radial load and permissible axial load can reduce assembly time.

◇ Permissible Radial Load and Permissible Axial Load

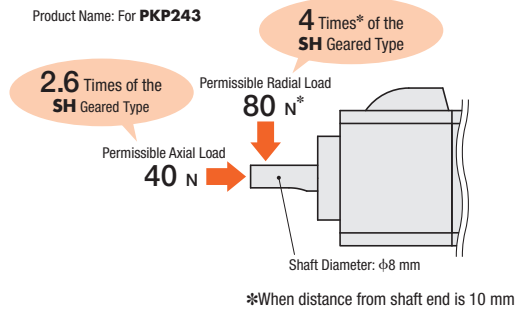

◇ Applications Belt and Pulley Mechanism

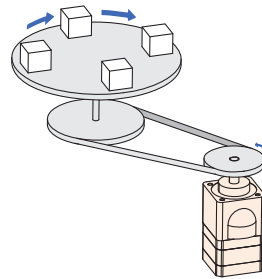

◇ Advantages

- Reduce adjustments during assembly because belt tension can be higher than with conventional products
- The components for supporting the radial load on the shaft are no longer needed
- The degree of freedom in pulley selection is increased

● Achieves Increased Torque with the Same Motor Frame Size

Switching to a geared type motor increases torque without changing the motor frame size. This is effective when installation is not possible because the motor installation space is limited.

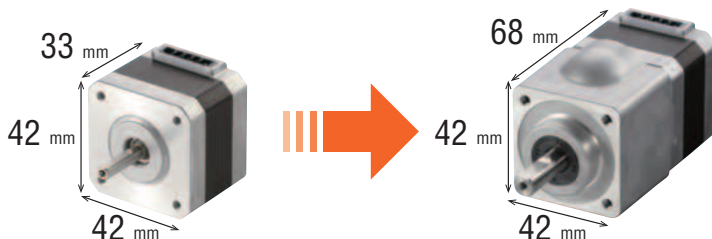

Standard Type	Motor Type	CS Geared Type
PKP243D15A2	Product Name	PKP243D15A2-CS20
0.35 N·m	Max. Holding Torque	2 N·m

● **Increased Torque Contributes to Reduced Size and Weight of the Motor**

High torque, shorter motor length and a frame size that's one size smaller.

◇ **Dimensions:** (Unit = mm)

CS Geared Type (PKP243D15A2-CS20)

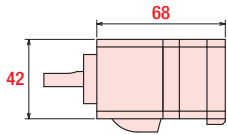

SH Geared Type (PKP264D14A2-SG7.2)

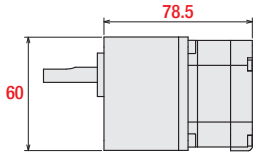

Maximum Holding Torque: Same
 Frame Size: **Reduced by 18 mm**
 Motor Length: **Reduced by 10.5 mm**
 Mass: **Reduced by 47 %**

◇ **Torque Characteristics Comparison**

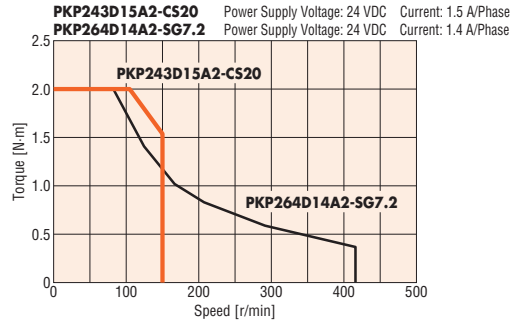

● **Center Shaft Makes Designing Easier**

A review of the gear structure has led to the center shaft design. It is easier to design the installation plate. In addition, the degree of freedom for the cable outlet direction has been increased.

● **Output Shaft now Placed in Center**

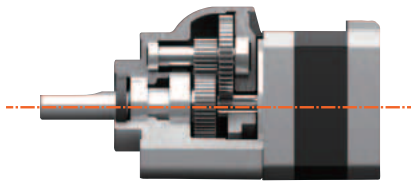

Internal Gearhead Structure Figure

● **Installation Plate Designing Made Easier**

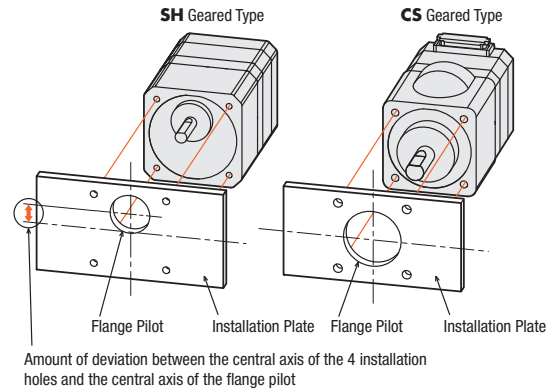

● **Increased Degree of Freedom for Cable Outlet Direction**

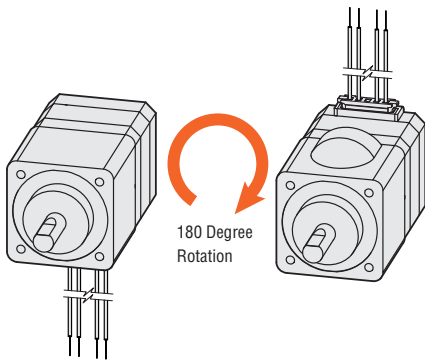

SH Geared Type

This type is well-suited for deceleration, increased torque, high resolution, and limited vibration. It experiences less backlash than conventional products.

● **Wider Speed Range makes it Easier to Use than Conventional Products**

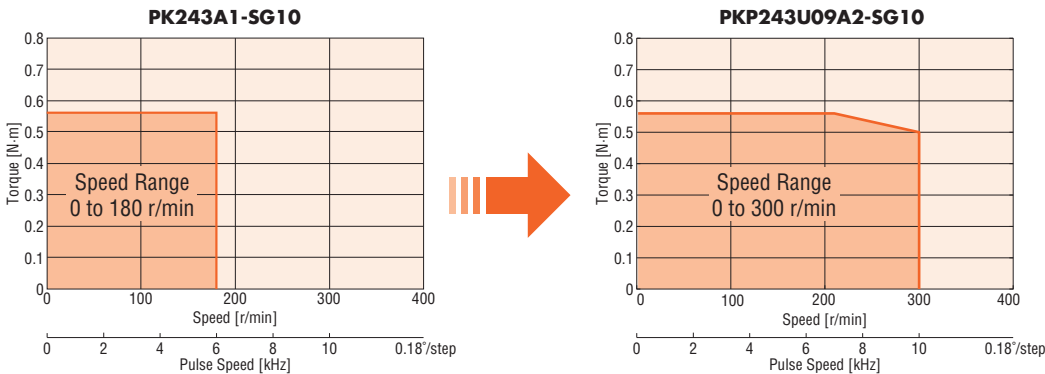

Product Line Equipped with Additional Functions to Broaden Applications

● With Encoder

(Available for standard type, high-resolution type, **SH** geared type)

◇ Main Specifications

Type	Standard Type	High-Resolution Type, SH Geared Type
Resolution	200 P/R, 400 P/R*	400 P/R
Angular Accuracy	±0.36° (Motor output shaft conversion value)	
Output Signals	A phase, B phase, Z phase (3 ch)	

*A product line with resolution of 1000 P/R is available with frame sizes of 42 mm and 56.4 mm.

● About Angular Accuracy (Diagram)

Angular accuracy is the error between the actual rotation angle and the angle output by the encoder.

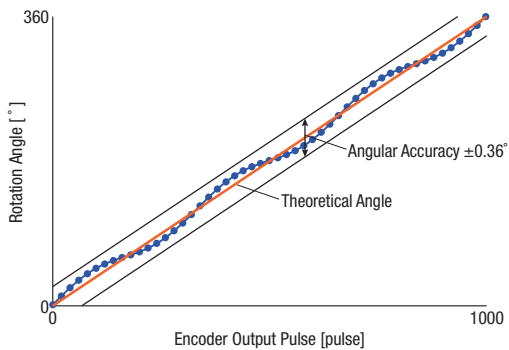

◇ Capable of Highly Repeatable Return-to-Home

The Z-phase signal is output using the excitation home (stable point), so the home sensor (the sensor that detects the home within one rotation, installed on the motor shaft) can be used instead.

It is also easier for the Z-phase output signal and TIM output signal* to be used together, increasing the repeatability of return-to-home.

*The signal output by the driver every time the motor output shaft rotates 7.2° (3.6° for high-resolution type) from home.

● If the Z-Phase Output Timing is Fixed New Encoder (Magnetic Type)

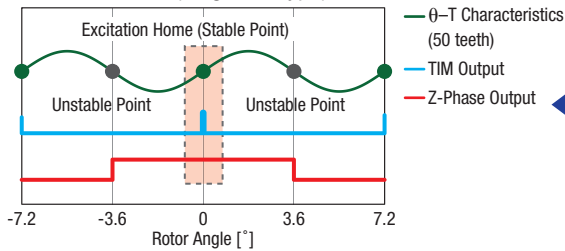

The Z-phase signal outputs with a width of ±3.6°, centered on the excitation home (stable point).

◇ Motor Position Detection is Possible

Monitoring the current position and detecting positional errors is possible.

For example, comparing the command position and current position enables you to ensure normal operation of the motor.

● System Configuration Example

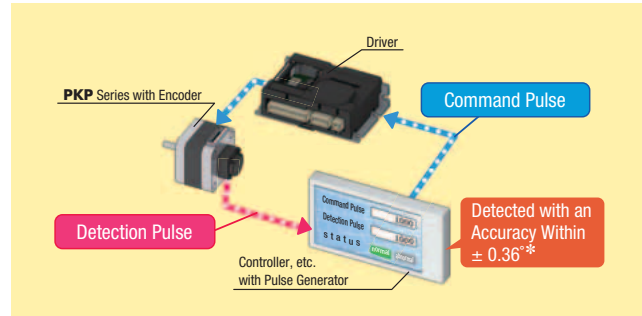

*Motor output shaft conversion value

● If the Z-Phase Output Timing is not Fixed

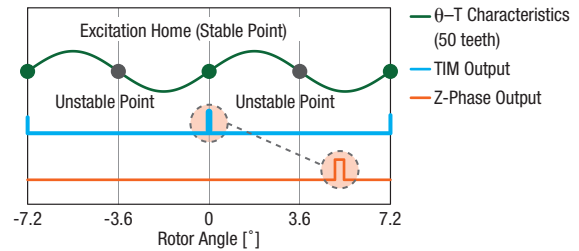

The Z-phase signal output timing is unstable, making it difficult to use it as a home sensor substitute, and also making it difficult to use it in combination with the TIM signal.

◇ Equipped with a Compact Encoder

● When frame size is 56.4 mm

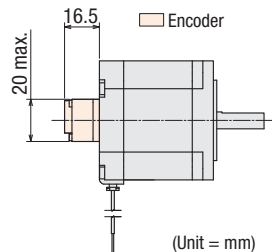

◇ Voltage Output Type and Line Driver Output Type Available

Both a voltage output type and a line driver output type are available.

● **With Electromagnetic Brake**

(Provided for standard type and high-resolution type)

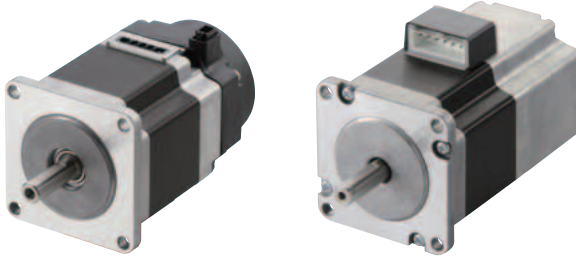

◇ **Position Can Be Held When the Power Is OFF or a Power Failure Occurs.**

This type features an electromagnetic brake that activates when the power is off.

When the power is accidentally cut off due to a power failure or other unexpected event, the electromagnetic brake holds the load in position to prevent it from dropping or moving. Also, the load can be held by the electromagnetic brake when the motor is stopped, and the heat generated by the motor can be curtailed by switching the motor current off.

Compatible Drivers (Sold Separately)

These are compact and lightweight bipolar drivers.

● Bipolar Driver CVD Series

The **CVD** Series offers the pulse input type and the RS-485 communication type drivers.

- Right Angle Type with Installation Plate
The connector points outward.

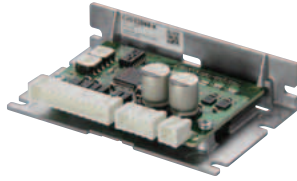

- With Installation Plate
The connector points upward.

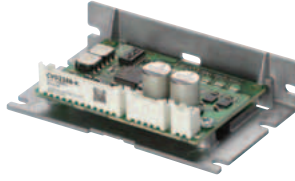

- Without Installation Plate*
The connector points upward.

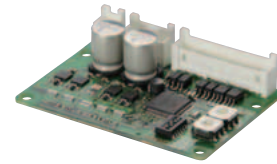

*Pulse input type only

● Bipolar Driver CVD Series S Type

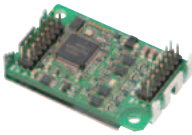



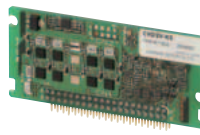



· SPI Communication-Compatible



· Pulse Input-Compatible

■ Product Line

Motor Product Line (Basic Step Angle)	Frame Size, Wiring Type														
	20 mm		28 mm		35 mm		42 mm		56.4 mm		60 mm		85 mm		
	Bipolar	Unipolar	Bipolar	Unipolar	Bipolar	Unipolar	Bipolar	Unipolar	Bipolar	Unipolar	Bipolar	Unipolar	Bipolar	Unipolar	
Standard Type (1.8°)	○	○	●	●	●	●	●	●	●	●	●	○*4	○*4	○	○
 With Encoder*5	○	—	●	—	●	—	●	—	●	—	—	—	—	—	—
 With Electromagnetic Brake	—	—	●	●	●	●	●	●	●	●	—	—	—	—	—
High-Resolution Type (0.9°)	—	—	●	●	—	—	●	●	●	●	—	—	—	—	—
 With Encoder*5	—	—	●	—	—	—	●	—	●	—	—	—	—	—	—
 With Electromagnetic Brake	—	—	—	—	—	—	●	●	●	●	—	—	—	—	—
Flat Type (0.018° ~ 1.8°)	—	—	—	—	—	—	●	—	—	—	○	—	—	—	—
 With Harmonic Gears	—	—	—	—	—	—	●*1	—	—	—	○*2	—	—	—	—
SH Geared Type (0.05° ~ 0.5°)	—	—	●	●	—	—	●	●	—	—	●	●	—	○*3	○*4
 With Encoder	—	—	●	—	—	—	●	—	—	—	●	—	—	—	—
CS Geared Type (0.09° ~ 0.36°)	—	—	●	●	—	—	●	—	—	—	●	—	—	—	—
	—	—	●	●	—	—	●	—	—	—	●	—	—	—	—

●: Connector Connection Method ○: Lead Wire Type

*1 Flat Type - 51 mm with Harmonic Gears.

*2 Flat Type - 61 mm with Harmonic Gears.

*3 The **SH** geared type is 90 mm.

*4 This is the conventional **PK** Series.

*5 Unipolar with encoder is also available. For details, please contact your nearest Oriental Motor sales office.

5-Phase Stepper Motors PKP Series

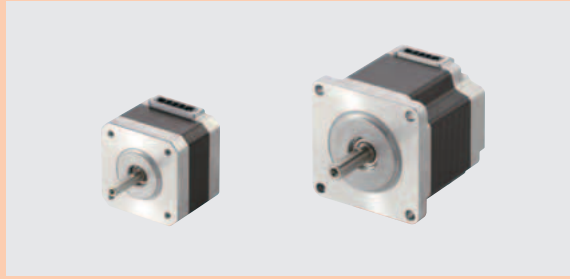

This is a high torque and low vibration stepper motor with a basic step angle of 0.72° (resolution of 500 steps per revolution).

High Positioning accuracy is possible, as well as low vibration and reduced noise.

(A separate dedicated driver is required to operate each motor.)

Features

High Accuracy

Since the step angle of 5-Phase Stepper Motors in the **PKP Series** is at 0.72° (high-resolution type at 0.36°) and the stopping accuracy is at $\pm 0.05^\circ$, highly accurate positioning is possible. In addition, the stop position accuracy controlled by a microstep driver has almost the same high accuracy as that controlled by a full-step driver.

Conventional 2-Phase Motor

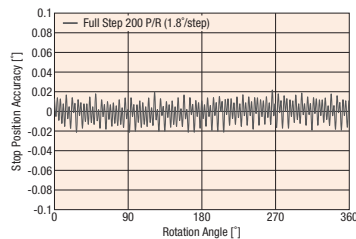

Stopping accuracy gets worse with Microstep

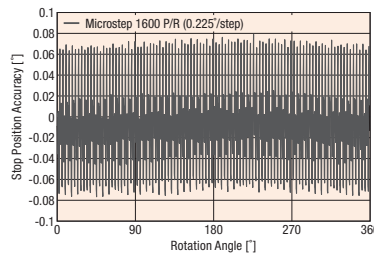

PKP Series Highly accurate positioning for 5-phase is possible

5-Phase **PKP Series**

(Driver: 5-phase **CVD driver**)

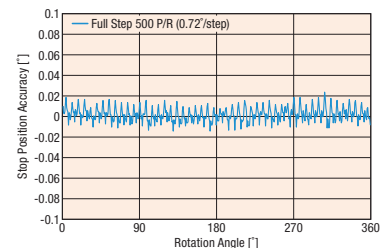

Stopping accuracy does not get worse with Microstep

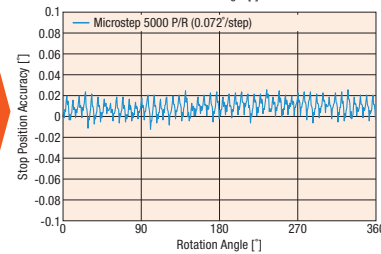

Low Vibration and Reduced Noise

Because the basic step angle is small at 0.72° (0.36° for high-resolution type), the vibrations and noise are lower than the 2-phase stepper motor with a basic step angle of 1.8° . Also, vibrations and noise can be further reduced with a microstep driver.

Example of 2-Phase Stepper Motor Vibration Characteristics

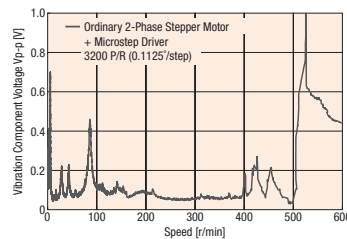

PKP Series Vibration characteristics for 5-phase are further improved

Example of 5-Phase Stepper Motor Vibration Characteristics

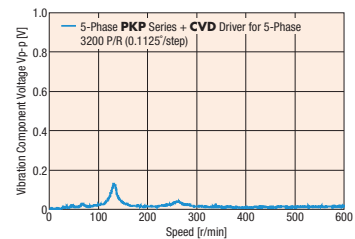

Lineup of Products Using Compact, Flat Connectors





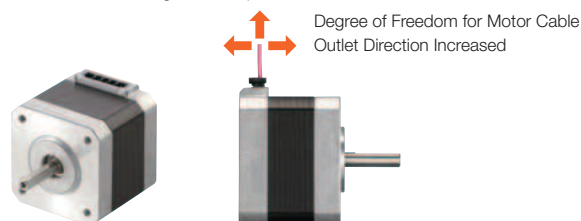







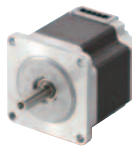



The product line offers products that use compact, flat connectors. The degree of freedom for the motor cable outlet direction has been increased, because the outlet direction points upward.

The connector configuration depends on the motor. Check the details in the motor dimensions.



Product Line

–: Not Offered in This Product Line

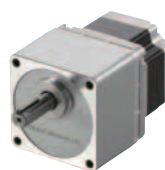
Type (Basic Step Angle)	Features	Frame Size					
		20 mm	28 mm	42 mm	56.4 mm	60 mm	85 mm
Standard Type (0.72°)	<ul style="list-style-type: none"> Standard model High torque, low vibration 	 *1					 *1 Lead Wire Type
High-Resolution Type (0.36°)	<ul style="list-style-type: none"> Resolution double that of standard type Results in high positioning accuracy and reduced vibration 	–			–		–
Standard Type with Encoder (0.72°)	<ul style="list-style-type: none"> Encoder resolution 500 P/R, A, B, Z (3 ch) signal output Uses compact encoder Angular Accuracy $\pm 0.36^\circ$*3 Capable of Highly Repeatable Return-to-Home 	 *1		 *2		 *2	–
High-Resolution Type with Encoder (0.36°)	<ul style="list-style-type: none"> Encoder resolution 1000 P/R, A, B, Z (3 ch) signal output Uses compact encoder Angular Accuracy $\pm 0.36^\circ$*3 Capable of Highly Repeatable Return-to-Home 	–			–		–
TS Geared Type (0.024° ~ 0.2°)	<ul style="list-style-type: none"> Spur gear mechanism A wide variety of low gear ratios, high-speed operations Gear ratio types: 3.6, 7.2, 10, 20, 30 	–	–		–		–

*1 This is the conventional **PK** Series.

*2 With frame sizes of 42 mm and 60 mm, a product line with resolution of 1000 P/R is also available.

*3 Motor output shaft conversion value

Product Line Equipped with Additional Functions to Broaden Applications

● With Encoder

(Provided for standard type and high-resolution type)

◇ Main Specifications

Type	Standard Type	High-Resolution Type
Resolution	500 P/R*	1000 P/R
Angular Accuracy	±0.36° (Motor output shaft conversion value)	
Output Signals	A phase, B phase, Z phase (3 ch)	

*A product line with resolution of 1000 P/R is available with frame sizes of 42 mm and 60 mm.

● About Angular Accuracy (Diagram)

Angular accuracy is the error between the actual rotation angle and the angle output by the encoder.

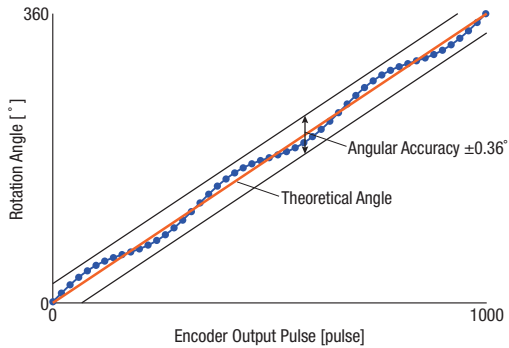

◇ Motor Position Detection is Possible

Monitoring the current position and detecting positional errors is possible.

For example, comparing the command position and current position enables you to ensure normal operation of the motor.

● System Configuration Example

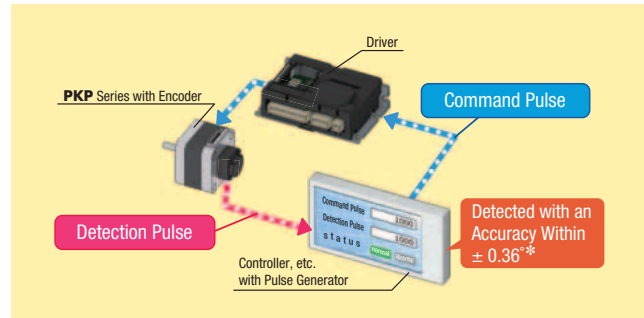

*Motor output shaft conversion value

◇ Capable of Highly Repeatable Return-to-Home

The Z-phase signal is output using the excitation home (stable point), so the home sensor (the sensor that detects the home within one rotation, installed on the motor shaft) can be used instead.

It is also easier for the Z-phase output signal and TIM output signal* to be used together, increasing the repeatability of return-to-home.

*The signal output by the driver every time the motor output shaft rotates 7.2° (3.6° for high-resolution type) from home.

● If the Z-Phase Output Timing is Fixed New Encoder (Magnetic Type)

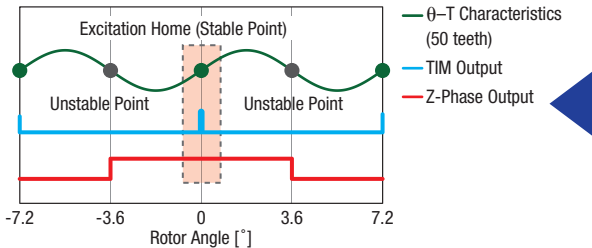

The Z-phase signal outputs with a width of ±3.6°, centered on the excitation home (stable point).

● If the Z-Phase Output Timing is not Fixed

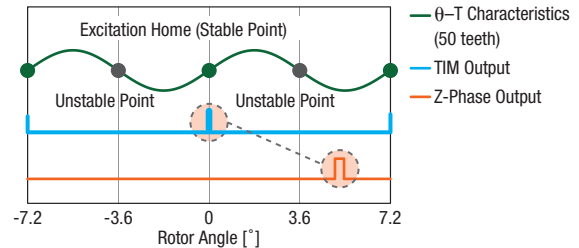

The Z-phase signal output timing is unstable, making it difficult to use it as a home sensor substitute, and also making it difficult to use it in combination with the TIM signal.

◇ Equipped with a Compact Encoder

● When frame size is 56.4 mm

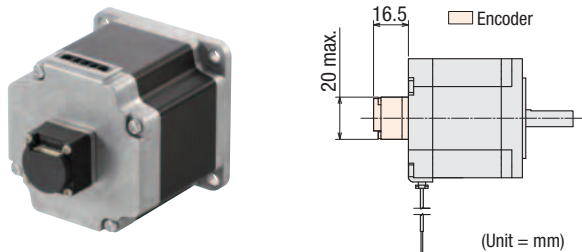

◇ Voltage Output Type and Line Driver Output Type Available

Both a voltage output type and a line driver output type are available.

CVD Series Driver for 2-Phase/5-Phase Stepper Motors

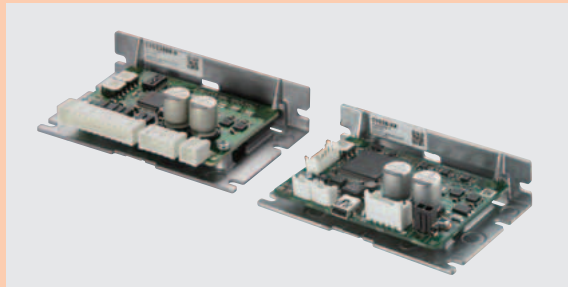

These are DC power supply input drivers for stepper motors. 2-phase stepper motors (bipolar drive) and 5-phase stepper motors are available. Using the microstep drive function for a low-vibration driver reduces vibration and noise.

Features and Types

- Bipolar Driver for 2-Phase Stepper Motor
- Driver for 5-Phase Stepper Motor
- CVD Series

Driver Type	External View	Overview	Driver Installation Direction	
<ul style="list-style-type: none"> ● CVD Series Pulse Input Type <ul style="list-style-type: none"> • Mass 20 g ~ 70 g (The value differs according to the driver type) 	Right Angle with Installation Plate	The connector points outward.	<ul style="list-style-type: none"> • Horizontal Installation • Vertical Installation 	
	With Installation Plate	The connector points upward.		<ul style="list-style-type: none"> • Can be controlled depending on the positioning module (pulse generator) • Running current can be easily set with the digital switch.
	Without Installation Plate	The connector points upward.		
<ul style="list-style-type: none"> ● CVD Series RS-485 Communication Type <ul style="list-style-type: none"> • Mass 65 g 	Right Angle with Installation Plate	The connector points outward.		<ul style="list-style-type: none"> • Compatible with RS-485 communication (Modbus Protocol) • Easy overwriting of data and multi-axis settings
	With Installation Plate	The connector points upward.		

Note

● The driver cannot be shared by both a 2-phase stepper motor and 5-phase stepper motor. Each must use its respective dedicated driver.

- For 2-Phase/5-Phase Stepper Motors Bipolar Driver CVD Series S Type

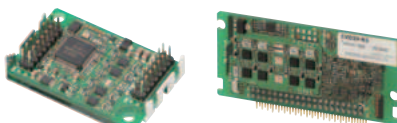

• SPI Communication-Compatible

• Pulse Input-Compatible

- For 5-Phase Stepper Motors Driver CVD Series SC Type

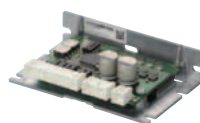

This driver can easily control speed by sensing the speed control motor. For details, please contact your nearest Oriental Motor sales office.

This is a compact board driver. For details, please contact your nearest Oriental Motor sales office.

ORIENTAL MOTOR U.S.A. CORP.

**Western Sales and
Customer Service Center**

Tel: (310) 715-3301

Fax: (310) 225-2594

Los Angeles

Tel: (310) 715-3301

San Jose

Tel: (408) 392-9735

**Midwest Sales and
Customer Service Center**

Tel: (847) 871-5900

Fax: (847) 472-2623

Chicago

Tel: (847) 871-5900

**Eastern Sales and Customer
Service Center**

Tel: (781) 848-2426

Fax: (781) 848-2617

Boston

Tel: (781) 848-2426

Toronto

Tel: (905) 502-5333

Technical Support

Tel: (800) 468-3982

8:30 A.M. to 5:00 P.M., P.S.T. (M-F)

7:30 A.M. to 5:00 P.M., C.S.T. (M-F)

Se Habla Español

Tel: (847) 871-5931

E-mail:

techsupport@orientalmotor.com

***Obtain Specifications, Online Training
and Purchase Products at:
www.orientalmotor.com***

Specifications are subject to change without notice.
This catalog was published in March 2024.

For more information please contact:

© Copyright ORIENTAL MOTOR U.S.A. CORP. 2024

This printed material uses paper
from responsibly managed forests
and Enviro/Tech inks.